



# Come home to comfort

Everything you need to know  
about air conditioning



# Contents

---

<b>Contents</b>	<b>2</b>
<b>Introduction</b>	<b>3</b>
What exactly is Air Conditioning?	3
Why LG Air Conditioning	3
<b>Choosing the Correct Model</b>	<b>4</b>
Which air conditioner model is right for me?	4
What happens if I choose a model that isn't the right size?	5
What are the running costs?	6
<b>What are the Different Types of Air Conditioners?</b>	<b>8</b>
Which option is right for me?	9
<b>Installation</b>	<b>10</b>
What are some important things to consider?	10
What are the installation costs?	10
<b>Key Technology</b>	<b>11</b>
Wi-Fi Smart control	11
<b>Contact</b>	<b>12</b>
How do I find my local dealer?	12

# Introduction

---

## What exactly is Air Conditioning?

Everyone should be pretty familiar with the basic principle behind air conditioning - it's the process of cooling down or heating up the interior of an occupied space, to improve people's comfort levels. But that's generally where most people's understanding stops. And there's far more to know about air conditioning than that.

In this handy guide, we're going to step you through everything you need to know about air conditioning.

1. The different types of air conditioners,
2. Which one is best suited to your individual needs,
3. Running costs,
4. Installation and much, much more.

And remember, if you need to find out more, make sure you talk to an LG Dealer.

## Why LG Air Conditioning

With stylish design cues, and the latest innovative technology, LG air conditioners give you the power to cool one room, or several, with just the touch of a button. Designed for the way you live, they're available in a wide range of styles - so you can create a space that's cool, comfortable and stylish. Whether you need a quiet, comfortable room, or simply want to heat /cool an area, our products set a high standard for efficiency, style and performance.

And with LG home air conditioning products, you'll also enjoy energy savings and prevention of harmful bacteria and particles. For ease of installation, energy efficiency and quiet performance, LG air conditioning systems are the smart choice.

# Choosing the Correct Model

---

## Which air conditioner model is right for me?

When choosing an air conditioner, there are various things to take into account. For example, a small room might require a small (2.5kW) model, while a large open-plan area might need a large 7kW model or even more.

To get an accurate idea, the following details need to be taken into account:

The size of the room. To calculate this, you not only need to take the length and width of the room into account, but also the height.

The type of room. Is it a lounge, kitchen, bathroom or bedroom? What is the room used for?

The size and orientation of the windows and glass doors. Does the room have large north facing windows, or a small window facing a courtyard?

Are there curtains or blinds on the windows?

Are the floors, ceilings or walls insulated?

What's the climate? Is it hot and tropical North Queensland, or cool and temperate Tasmania?

All these factors should be taken into account. And that's why we recommend you talk to one of our LG specialist dealers.

# What happens if I choose a model that isn't the right size?

It's important to get the right size model for your room but if that's not possible, it's probably a safer bet to get a model slightly above the required capacity than slightly below it; a little extra power may help in extreme temperatures. But don't go too much above the required capacity.



Premium 3.5kW Reverse Cycle Split System

WH12SK-18

## Overpowered models

Models too powerful for the room size will probably run lots of short cycles to achieve the ideal temperature. That's like tapping the accelerator of your car to maintain ideal speed instead of applying steady pressure. This can result in the room getting too cold or hot; inadequate dehumidification (i.e. not drying the air enough, making the room feel less comfortable); increased power usage and running costs; and wear and tear on the system

## Underpowered models

Underpowered models will have to run more often at maximum output which means they'll suffer from excessive wear. They also dry the air too much.

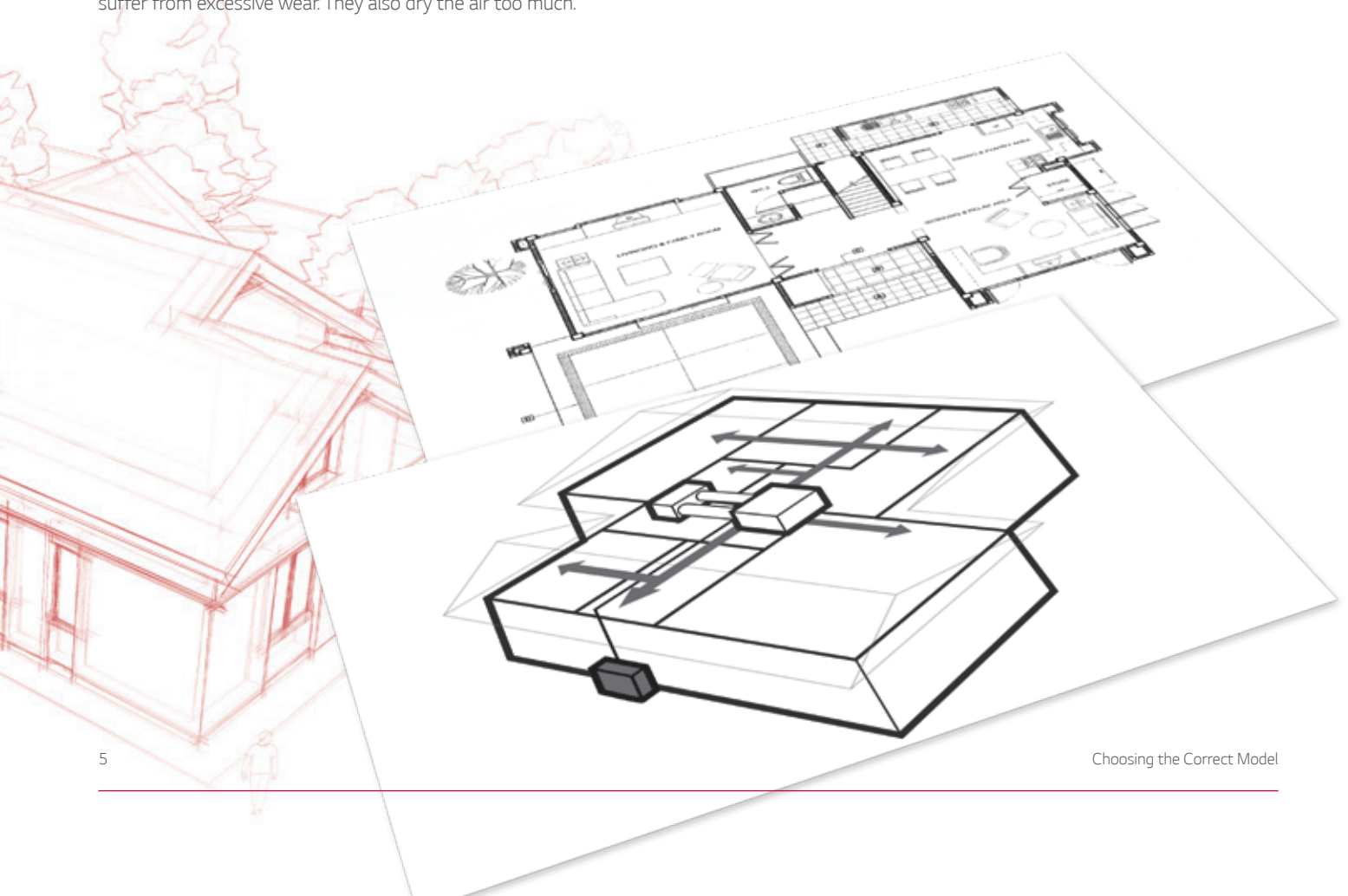

# What are the running costs?

In the the average Aussie home, heating and cooling accounts for about 40%<sup>1</sup> of total energy usage, so it's vital you make the right decision upfront. To save money when running your air conditioner, there are several things to consider:

## Size

As discussed in the 'Choosing the correct model' section, the size of the air conditioner is the first and most important consideration.



## Star Ratings

Star ratings are an effective way to check power usage. Models with more stars are more efficient and use less power than models with fewer stars.

## Energy Efficiency

There are things you can do to make your home more energy efficient.

Here are three things you can try:

1. Install blinds on windows facing the direct sun to help reduce the heat in the room. Sealing the windows properly will also prevent the cool air escaping, as well as keeping the hot air out.
2. Opening up the home once the evening breezes come in after a hot day is a great no-cost way to cool your home quickly.
3. Simply close the doors and allow the air conditioner to effectively and efficiently cool the rooms you will be spending time in.

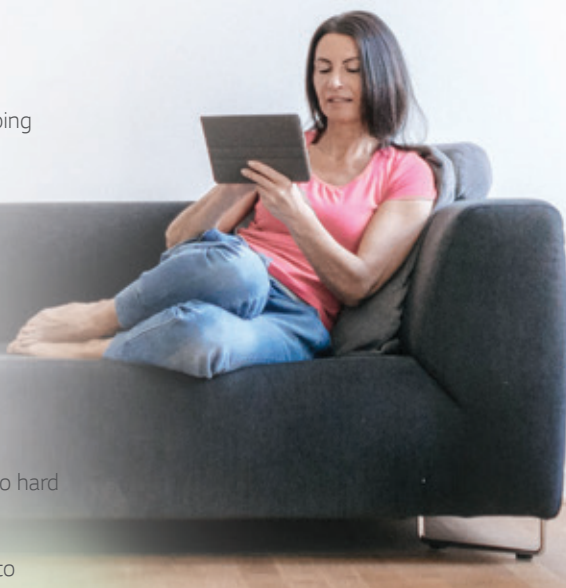

## Energy Management

Set the thermostat to a reasonable temperature so the system doesn't have to work too hard and use more power than really necessary.

On a scorching, hot day you'll probably be tempted to put the air conditioner way down to 20°C to cool the room as quickly as possible. But if you set the temperature to a manageable 25°C, you will not only save on wear and tear on the air conditioner's motor, you will save big on your energy bill.

The same principle applies in winter. If it's 15°C outside, try setting the indoor temperature to 18°C rather than 25°C (and pull on that woolly jumper you got for Xmas).

Why is this so important? Well just consider for a moment that changing the temperature by just one degree cooler (or one degree warmer in winter) can add about 10%<sup>2</sup> to your total running costs.

LG's Active Energy Control also helps as it allows you to cap energy consumption to improve energy efficiency and reduce power consumption at a reduced cooling output. To find out more about your energy costs visit [www.energyrating.com.au](http://www.energyrating.com.au).

## Dehumidifier

Excess dampness due to heat and humidity, or cold and damp, can be a real issue. For persistent dampness, a dehumidifier might be the answer.

Your air conditioner is a good option for controlling warm humid air. Cooling mode not only cools the air but also removes air moisture, which makes the air feel more comfortable.

Many models also have a “dry” or “dehumidify” mode to dry the air, which is best used when the air is warm and humid. The indoor fan speed is reduced so that the air spends longer moving over the cooling coils, in order to extract more moisture from the air. Dry mode can be an efficient and effective option in those conditions as reducing the humidity makes the air feel cooler and more comfortable. But when it’s very hot and only moderately humid, cooling mode will be much more effective.

## Checklist

To help with your decision, we’ve created this handy checklist:

- Beat the rush. If you want to beat the Summer heat, make sure you plan ahead.
- Figure out your budget and what can you afford. But remember, the cheapest option may not be the most efficient and can end up costing you more in the long run.
- Do you want to heat or cool whole house or just one area?
- What size do you need? Remember the best advice will come from a dealer.
- Where do you want to install the unit?



# Types of Air Conditioning

---

## What are the different types of air conditioners?

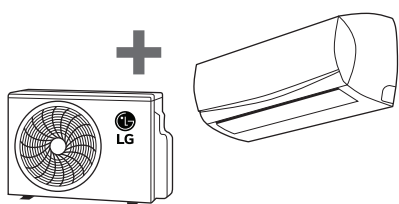

### Split System

A split system air conditioner is comprised of two parts: an outdoor compressor unit and an indoor unit connected by pipes. They're usually used to cool one or more rooms, or an open-plan area, of up to 60 square metres.

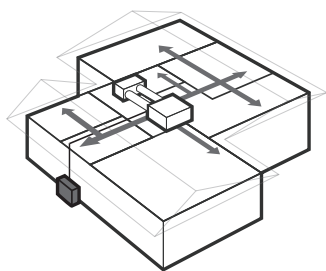

### Ducted

This type of air conditioner consists of a central unit connected by ducts to air outlets and sensors in each room, with a control panel to set the target temperatures in each zone. This is the best option for temperature control throughout a large home.

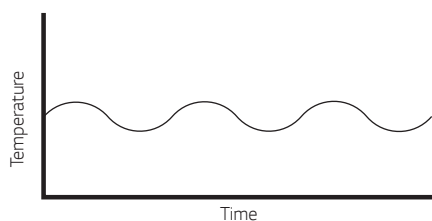

### Inverter / Non Inverter

With an inverter model, you can vary the compressor speed. This means the compressor (the outdoor bit) doesn't need to switch on and off all the time, but instead just speeds up or down as need demands.

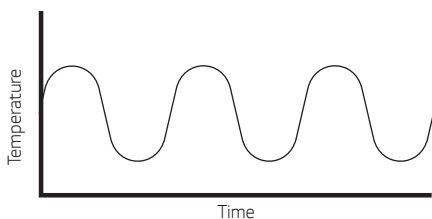

By not actually having to stop and start several times a day, there's less stress on the compressor and less electricity is used, so inverter models are generally more efficient and cost less to run. They can maintain a set temperature within a narrow range. These days, most split system models are inverters.



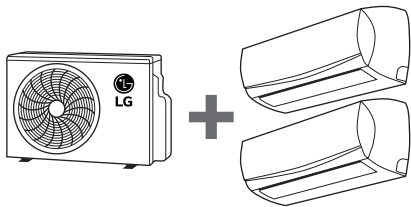

## Multi Split

A type of split-system model, where one outdoor unit is connected to two or more indoor units. This can be a good way to cool or heat two or three rooms that are reasonably close together, when separate split-systems or a ducted system aren't possible due to space limitations.

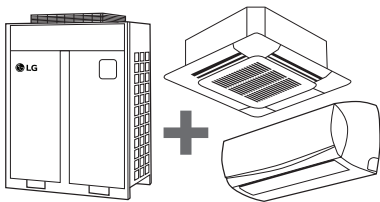

## VRF

VRF stands for Variable Refrigerant Volume. VRF is very similar to a multi-split but much larger and capable of connecting more indoor units. VRF can be the most efficient type of system but is generally installed in high-end homes and high-rise apartments.

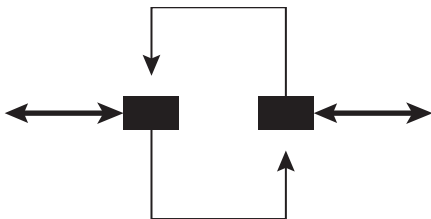

## Reverse-cycle

Reverse-cycle models can be used for cooling in summer and heating in winter. While the purchase and installation costs can be high compared to an electric heater, reverse-cycle air conditioners are actually among the cheapest and most effective forms of heating for large spaces over the long term. Even if you only need heating for a few days or weeks each winter, a reverse-cycle model could be your best option.

## Which option is right for me?

So here's the million dollar question. Which model is right for me? As you can see, there are loads of factors to take into account. That's why we strongly recommend you talk to a dealer first.

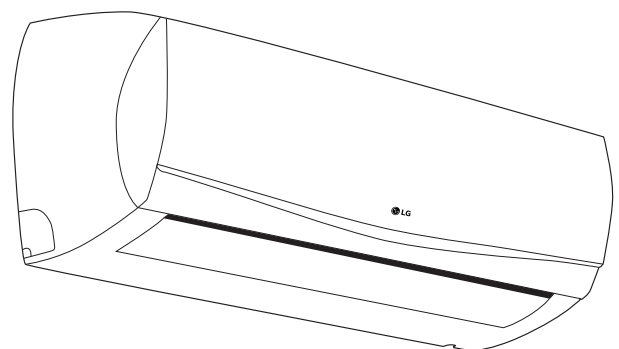

# Installation

---

It's important to consider the installation process before purchasing an air conditioner.

## What are some important things to consider?

The installation of an LG air conditioner must be done by a licensed LG air conditioner installer, due to the refrigerant gas handling that's required. Look for an installer with ARCTick approval, and make sure you get a few quotes.

Your dealer will be able to advise the best place to install your indoor unit for maximum efficiency and product performance.

The outdoor unit of your split system needs to be installed on a firm base (for example, a concrete slab) or attached to a wall, using sturdy brackets.

Try to shade the outdoor part of your air conditioner from direct sunlight – for example, by installing it on a southern wall or providing an awning.

Again, your dealer will be advice the best location for your outdoor unit.

## What are the installation costs?

Due to a large amount of variable factors, installation costs can vary widely. Most traders offer supply and install packages so make sure you check with them first.



ARCTick authorised badge  
learn more at:  
[www.lookforthetick.com.au](http://www.lookforthetick.com.au)



# Key Technology

## Come home to comfort

You probably know LG for our world leading big screen TV's. In fact, LG develops technology for a wide range of products, and builds and designs its own core technology and components for its air conditioners.

LG also has energy solutions that can be used in the whole home, ranging from solar panels, batteries and Home Energy Management. This holistic approach allows energy to be moved where it's needed, allowing the best possible usage of collected power.

## Wi-Fi Smart Control

### Easy connectivity

The LG SmartThinQ app lets you access and control your air conditioner using your smartphone, even when you're not at home.

### Improved convenience

The LG SmartThinQ App\* lets you easily access and control your air conditioner from your mobile phone. Up to five users can connect to one unit, although only one user can control the unit at a time. A user can individually control multiple units using the app.

Visit: [lg.com/au/air-conditioning](http://lg.com/au/air-conditioning) to find out more about LG AC Technology such as Active Energy Control, Auto Clean, Pollutant filtration and much more.



Wi-Fi Module built-in for WH Series



Wi-Fi dongle required for P18-28 Splits  
B30-55 Standard Ducted  
B30-70 Premium Ducted

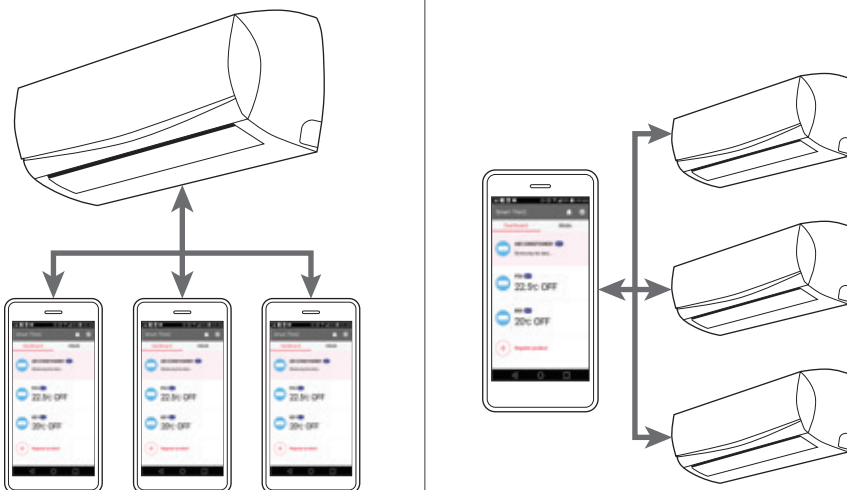

## Smart Diagnosis™

Smart Diagnosis provides usage tips and useful information based on your product usage patterns. If you experience a problem while using the product, we will help you to troubleshoot it using the Smart Diagnosis results.

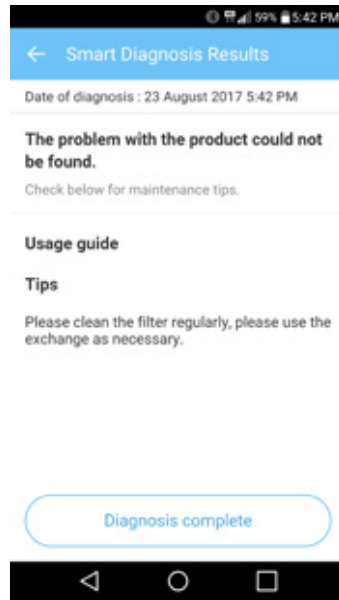

## Remote control like no other

All of the functions of your remote control, but from just about anywhere in the world.\*

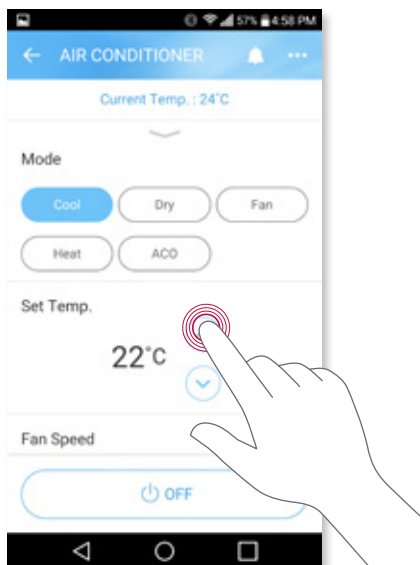

Set your preferred temperature, fan speed, air flow, operation mode (cool/dry/heat) and save in a special icon.

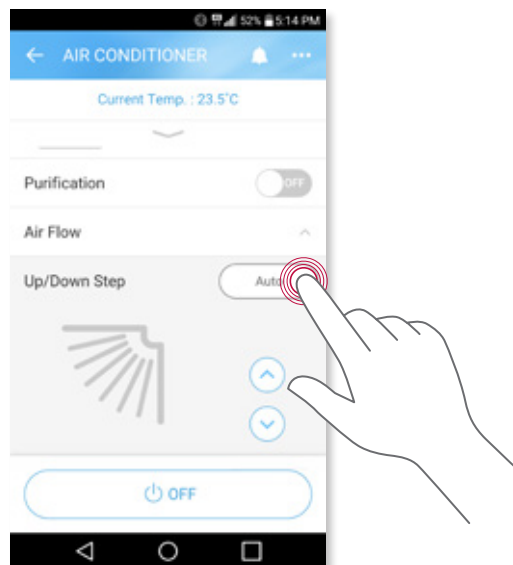

Just touch the icon to initiate your chosen settings.

# Contact

---

## How do I find my local dealer?

Looking for the perfect LG Air Conditioner for your home? Contact one of our specialist dealers for advice and more.

Simply visit [www.lg.com/au/specialist-retailer-locator](http://www.lg.com/au/specialist-retailer-locator)

